



Numbers™ Desk

Triangle Desk

MODEL#: 02133



OVERVIEW

Numbers™ desk is a winning answer for creating inspirational classrooms around the world. The desk delivers impressive benefits that add up for students and schools - great value and quality in a compact, sleek design that appeals to all ages. This desk answers the need for value-driven, high-quality classroom solutions with international design appeal. Numbers' compact, sleek look suits all ages, and the product specifications is designed to comply with BIFMA, EN, & GB standards for durability, performance and sizing. Together, the chair + desk suite equals a smart solution for students, teachers and facility personnel.

MATERIALS

The LEG SETS are made of 14 gauge steel circular stems and inserts. Larger tube 28.6mm x 14ga. steel and smaller tube 22mm x 14ga. steel. Standard inserts range from 24.5 to 30 inches; low-range inserts are 19 to 24.5 inches (Low range inserts sold separately). In addition, the inner leg tube can flip 180 degrees between glides or casters (sold separately), which allows for wheelbarrowing without affecting desk height.

FRAME consists of two fully welded segments. Legs have a full, even and long lasting powdercoat finish. To conserve space, the desks have a compact design. Their leg form, coupled with backpack hooks (with felt) on all four legs, allow easy slide-on stacking, three or four desks at a time.

The WORK SURFACE is made of 1 1/4" thick, high density particle board core, with HP Laminate top surface. Tops are pre-drilled for leg set attachment and ease of installation.

NUMBERS™ DESK TOP & EDGE PROFILE



DIMENSIONS

Model	Description	D"	W"	H"	F.C.	Cube	WT
02133	Numbers™ Triangle Desk	29	32	24.5-30	400	44	30.25

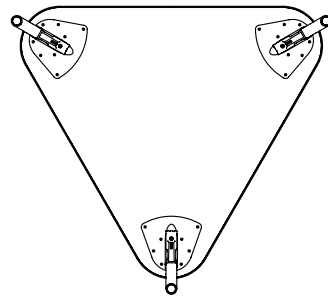
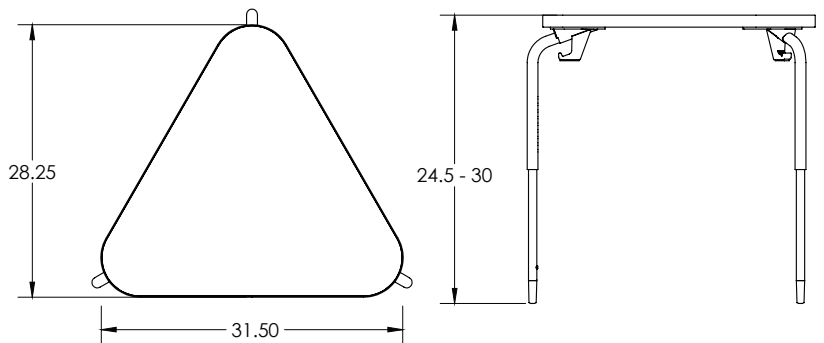

OPTIONAL ADD ONS



Model: 60168BLA
2" Caster w/lock



Model: 60161
Numbers student desk low range insert
(4pk)

STANDARD LAMINATE OPTIONS

Want to specify a different laminate?





No problem. If you have 20 or more tops of the same color -60 or -38 there is no upcharge. Have 20 or less? We can quote for you with the Wilsonart code and - finish style. We can specify other laminates - call to inquire and get a quote.



Felt-bottomed backpack hooks on all four legs

SUGGESTED LAMINATE OPTIONS (with matching 3mm Edge Band)



						
ASIAN NIGHT 7949-60 ANG	BOARDWALK OAK 7983-60 BWK	PEWTER MESH 4878-60 PEW	CLASSIC LINEN 4943-60 CLN	HIGH RISE 4996-60 HRE	NEW AGE OAK 7938-60 NEW	NORTH SEA GRAY D90-60 NOS

			
BUKA BARK 7982-60 BBK	PALISADES OAK 7987-60 PSO	FLAX LINEN 4990-60 FLL	MISSION MAPLE 7990-60 MIM

All 15 of the standard laminates are -60 finish, if you need to match a laminate from a previous year, please let us know on your order (example Pewter Mesh 4878-38, our standard is -60).

When the WilsonArt Laminate code includes a "Y", "K", "-12", "-78", "Aeon" etc, these are special laminates with an upcharge, even when it contains -38 or -60.

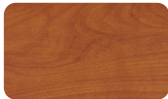
Classic Standard Laminates:

			
FRENCH PEAR 8220-60 FRP	WILD CHERRY 7054-60 CHE	GREY NEBULA 4622-60 GNB	FUSION MAPLE 7909-60 MAP

STANDARD EDGE COLOR OPTIONS - Additional Lead Time

						
APPLE APL	BLACK BLK	BLUEBERRY* PBL	BURGUNDY* BUR	CERULEAN CER	CHAMPAGNE CMP	CHARCOAL CGR
						
FOREST GREEN* FGR	NAVY NVY	ORANGE* ORG	PERSIAN BLUE PBL	PLATINUM PLT	PURPLE* PUR	RED* RED
						
YELLOW* YEL						

LEG COLOR

PLATINUM PLT